

pH/ORP Conductivity / TDS / Salinity Dissolved Oxygen Meter

Operation Manual

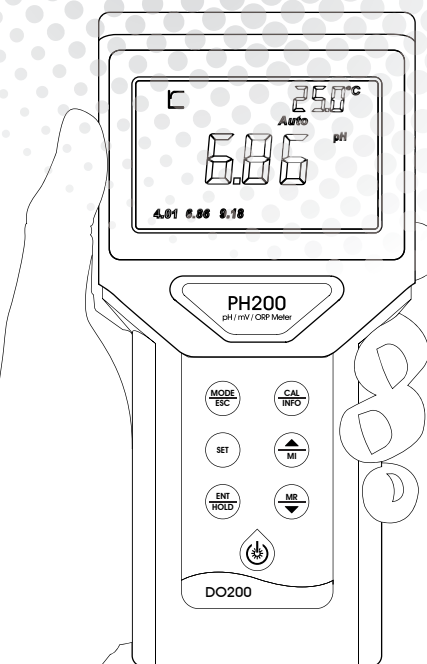

PH200/CON200/DO200 Meter

www.cleaninst.com
Customer Service: CS@cleaninst.com

CLEAN INSTRUMENTS
2006, No.511 Tianmu W. Rd. Shanghai 200070, China
11F No.25,Siwei St., Zhonghe Dist.,New Taipei City 23570, Taiwan



www.cleaninst.com

2013.07

PH200

CON200

DO200

7.7.2 Water saturated dissolved oxygen in different temperature

(Atmospheric Pressure 101325Pa 100% RH Salinity 0‰)

Temperature°C	Dissolved oxygen(mg/L)	Temperature°C	Dissolved oxygen(mg/L)
0	14.64	20	9.08
1	14.22	21	8.90
1	13.82	22	8.73
2	13.44	23	8.57
3	13.09	24	8.41
4	12.74	25	8.25
5	12.42	26	8.11
6	12.11	27	7.96
7	11.81	28	7.82
8	11.53	29	7.69
10	11.26	30	7.56
11	11.01	31	7.43
12	10.77	32	7.30
13	10.53	33	7.18
14	10.30	34	7.07
15	10.08	35	6.95
16	9.86	36	6.84
17	9.66	37	6.73
18	9.46	38	6.63
19	9.27	39	6.53

7.7.3 Factory defaults

Item	Corresponding interface	Factory Defaults
Atmospheric Pressure	P - 01	1013 mBar
Salinity	P - 02	0.0 g/L
Auto Lock	P - 04	OFF
Auto power off	P - 05	ON
Backlight		OFF
Unit of the displayed value		%

TABLE OF CONTENTS

1 Preface	01
1.1 Before Use	01
1.2 In Use	01
1.3 Safety	01
2 Basic Operation	02
2.1 Battery	02
2.2 Electrode Installation	02
2.3 Shell	02
2.4 Power on/off and Backlight	02
3 Key Panel	03
3.1 Key instruction	03
3.2 Key function	03
4 Appearance	04
4.1 Display	04
4.2 Display Character Table	05
pH / ORP	06
5.1 Technical Specifications	07
5.2 Browse the parameter	07
5.3 pH Set UP	08
5.3.1 P01 pH Standard Solution	08
5.3.2 P02 Manual Temperature setting	09
5.3.3 P03 Temperature Offset setting	10
5.3.4 P04 Auto Lock Function setting	11
5.3.5 P05 Auto Power Off Setting	12
5.3.6 P06 Clearing Memory Function	12
5.3.7 P07 Reverting to Factory Default Setting	13
5.4 Calibration Mode	14
5.5 Measurement Mode	15
5.6 Storage of Data	16
5.7 Calibration Parameter and Setting Parameter	17
5.8 Appendix	18
Conductivity / TDS / Salinity	19
6.1 Technical Specifications	20
6.2 Browse the parameter	20
6.3 Set UP	21
6.3.1 P01 Cell Constant (K)	21
6.3.2 P02 Temperature Compensation Base	22

7.7.1 The corresponding Average Atmospheric Pressure with the Altitude

Altitude h/m	Average Atmospheric Pressure ph/kPa	Altitude h/m	Average Atmospheric Pressure ph/kPa
0	101.3	2800	71.4
100	100.1	2900	70.5
200	98.8	3000	69.6
300	97.6	3100	68.7
400	96.4	3200	67.9
500	95.2	3300	67.0
600	94.0	3400	66.2
700	92.8	3500	65.4
800	91.7	3600	64.6
900	90.5	3700	64.6
1000	89.4	3800	63.0
1100	88.3	3900	62.2
1200	87.2	4000	61.4
1300	86.1	4100	60.7
1400	85.0	4200	59.9
1500	84.0	4300	59.2
1600	82.9	4400	58.4
1700	81.9	4500	57.7
1800	80.9	4600	57.0
1900	79.9	4700	56.3
2000	78.9	4800	55.6
2100	77.9	4900	54.9
2200	76.9	5000	54.2
2300	76.0	5100	53.5
2400	75.0	5200	52.9
2500	74.1	5300	52.2
2600	73.2	5400	51.6
2700	72.3	5500	50.9

- 6.3.3 P03 Conductivity Temperature Factor 22
- 6.3.4 P04 TDS Factor 23
- 6.3.5 P05 Temperature modified Factor 23
- 6.3.6 P06 Auto Lock Function Setting 24
- 6.3.7 P07 Auto Power Off Setting 24
- 6.3.8 P08 Clearing Memory Function 25
- 6.3.9 P09 Reverting to Factory Default Setting 26
- 6.4 Setting Parameter** 27
- 6.5 Calibration** 28
- 6.6 Appendix** 29
 - 6.6.1 Conductivity sensor measuring range 29
 - 6.6.2 Factory Defaults 29
- Dissolved Oxygen** 30
- 7.1 Technical Specifications** 31
- 7.2 Browse the parameter** 32
- 7.3 Set UP** 32
 - 7.3.1 P01 Atmospheric Pressure 32
 - 7.3.2 P02 Salinity Compensation 33
 - 7.3.3 P03 Temperature Offset 33
 - 7.3.4 P04 Auto Lock Function Setting 34
 - 7.3.5 P05 Auto Power Off Setting 34
 - 7.3.6 P06 Clearing Memory Function 35
 - 7.3.7 P07 Reverting to Factory Default Setting 36
- 7.4 Calibration** 37
- 7.5 Measurement Mode** 38
- 7.6 Storage of Data** 39
 - 7.6.1 Storage of measuring data 39
 - 7.6.2 Browse on data storage 39
 - 7.6.3 Setting parameter 40
- 7.7 APPENDIX** 41
 - 7.7.1 The corresponding Average Atmospheric Pressure with the Altitude .. 41
 - 7.7.2 Water saturated dissolved oxygen in different temperature 42
 - 7.7.3 Factory defaults 42
- 8 GENERAL INFORMATION** 43
 - 8.1 Warranty 43
 - 8.2 Return Of Malfunction Instruments 43
 - 8.3 Guidelines Or Returning Unit For Repair 43

7.6.3 Setting parameter

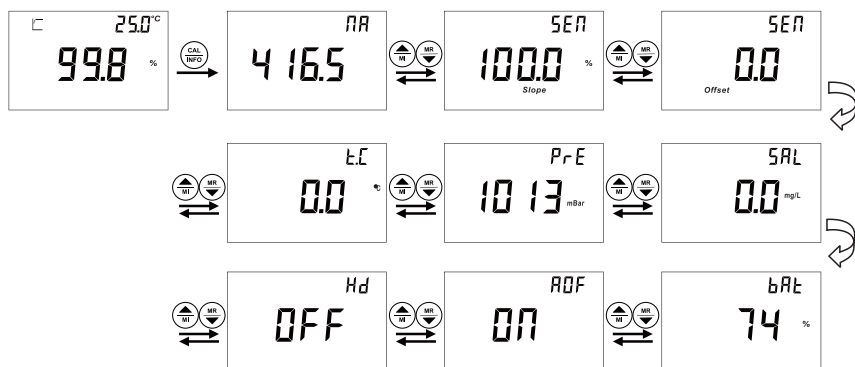

1. Long press to enter into Setting parameter when in measurement mode. Press to check through all the parameters.
2. Press to quit and go back to measurement mode.

1 Preface

1.1 Before Use

Thank you for selecting CLEAN meter. Although the meter use advanced technology and meet the requirements of current safety rules, improper use can still threaten the safety of users, and / or cause harmful influences to factory and other equipments. Therefore, before using the meter, relevant person must read and understand contents of this operation manual.

Operation manual should be kept accessible within the person who use the meter. If you have problems which are not mentioned or can not be explained in this manual, please contact CLEAN local customer service center. They will be very glad to help you.

1.2 In Use

On any unmentioned use or the use that contradict with the technical parameters the operators should bear the responsibility.

Other conditions of right use include:

- Remarks and requirements stated in operation manual.
- Local safety regulations on safe operation.
- Information and warning of products that are used together with the meter in the contract. (chassis, electrode, etc.)
- Required operating environment and working condition.

1.3 Safety



- The meter may only be carried out by trained experts.
- Unqualified meter should not be installed and used.
- The meter should be used under the required working condition.
- The meter should not be opened and repaired by clients themselves.
- Modified meter should not be used. Manufacturers and suppliers do not bear responsibility for the damage and lost caused by modifying instruments without permission. Clients should bear all the risks.
- This instrument is IP67 rated. Please use waterproof cable glands when you connect the cable. Also, please loose it when you open the cover. After connecting the cable, please tighten the cable conductor according to the following instruction with cable ties, or it will cause danger such as cable conductor or interface falls off when open the cover.
- Please make sure to cut the power off when you open the cover to carry on any operation.

2 Basic Operation

2.1 Battery

Use the coin to remove the battery cover by following the “-” direction.
Insert 2*7AAA batteries in the battery compartment with the correct Positive and Negative poles.
Tight the battery cover by following the “+” direction.

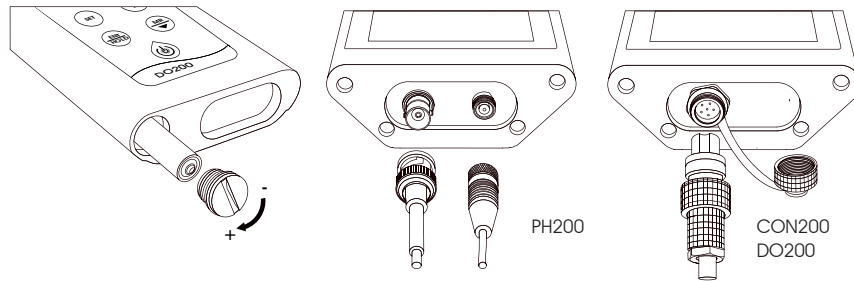

2.2 Electrode Installation

You can refer to the Electrode operation manual for use and maintenance. The direction of the red dot marker on the Electrode and the salient point on the unit should be the same when install the electrode to the unit. Remove the electrode by pulling out the clamp on the electrode.

2.3 Shell

This series of meter is portable and water-proof, with IP67 rated. If the meter accidentally touches water or other fluids, pls wipe it clean immediately. The meter function is not affected usually. But if affected and cannot use, (possibly because of the battery cover is not tight and penetrated by water). Please contact our company or CLEAN local customer service center. They will be very glad to help you.

2.4 Power on/off and Backlight

Power on

Short press power on/off key to start the meter. You can hear the indicator tone and whole screen displayed within 1 second.

Power off

Long press the power on/off key to power off the meter.
Auto power off in 10 minutes if without any operation.



LCD backlight

Short press power on/off key to control if turn on the backlight or not.

7.6 Storage of Data

7.6.1 Storage of measuring data







1.If you need to save the measuring data once it is stabilized, press  , the Lot no. will be shown on the upper right of the screen. Press  to save the data. You can also press  to not save. The meter will automatically go back to measurement mode after data saved. The unit at most can save 50 sets data. The screen will show “OVER” if more than 50 sets reminds you the memory card is full.

2.Enter into setting mode P-06 if you need to delete the saved data forever. You can refer to Clearing memory function.



7.6.2 Browse on data storage



1. Press  to enter into the browse on the data storage , the Lot no. will be shown and data twinkling. Press   to check all the saved data. Press  to go back to measuring mode. If showed “NONE” means no data is saved yet.

2. If you quit and re-entering during checking the data, the meter will freeze in the last set of data.

7.5 Measurement Mode

1. You can first set the meter per your request. Otherwise, the setting will be factory defaults.
2. Before each measuring, first lay aside the electrode for around 15mins to fully activate the sensor after the electrode is connected with the meter.
3. After power on, press  to select the operation mode (% or mg/L).
4. Immerse the electrode in the solution and stir gently. The measuring mark will twinkle. You can read the value once the data is stabilized and shows the stable symbol .
5. If the Auto Lock Function is ON, the meter can lock the measured value after the reading had stabilized and display . Press  to unlock.
6. If the changed temperature is needed, you can refer to P-03 Temperature Offset.

3 Key Panel







3.1 Key instruction

Short press: Short press means release the key once after pressing. (If there is no mark out below, default it as Short press)

Long press: Long press means press the key for 3 seconds and release.

Hold: Hold means not release the key, used in adjusting data and accelerate after a certain time. Not release the key until the value is set as needed.

3.2 Key function:

Key	Description
	Power on ON/OFF backlight Long press to Power off
	Mode switch Exit from current mode operation
	Data setting
	Enter into calibration mode Long press to enter into parameter browsing
	Freeze or unlock the displayed value
	Store the displayed value into memory Increment values or scroll through the next options available
	Recall stored values from the memory Decrement values or scroll through the next options available

4 Appearance

4.1 Display

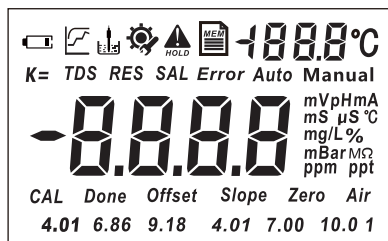

- 1 Measuring Status-Calculating
- 2 Measuring Status-Stable Value
- 3 Electrode inserted display
- 4 Setup display
- 5 **Offset** - Electrode Offset
- 6 **Slope** - Electrode Slope
- 7 **Done** - Calibration Done
- 8 **mV**、**PH**、**mA**、**°C**、**%**、**ms**、**uS**、**°C**、**mg/L**、**ppm**、**ppt**、**g/L**、**mBar** - Unit of Measurement
- 9 **Auto / Manual** - Temperature Compensation
- 10 **4.01**、**7.00**、**10.01** Calibrated Points -USA Buffer Standard
- 11 **4.01**、**6.86**、**9.18** Calibrated Points - NIST Buffer Standard

7.4 Calibration

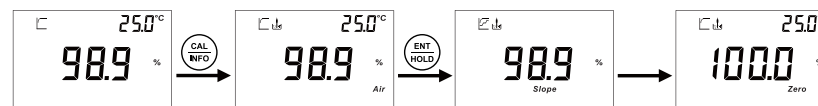

1. In measurement mode, press to enter calibration process.
2. First point calibration-100% air calibration: put the sensor in air, after you get a stable value or the stable symbol shows up, press key to confirm 100.0% saturated dissolved oxygen point.
3. After pressing , the electrode Slope will be showed on the screen. Then automatically initiate second point calibration -0% point calibration.

Note: Factory defaults first point 100% air calibration. If you don't need to calibrate 0% point, press key to go back to measurement mode.

After air calibration, the meter will automatically initiate second point calibration:



1. Dip the sensor in standard solution, when the value is stable, press key to confirm 0% point. Then system go back to measurement mode.
2. If you need to adjust the Atmospheric Pressure Compensation and the Salinity Compensation according to local situation. You can set in P-01 and P-02.

Illustration on the calibration point symbols:

1. The "Air" is shown at the right bottom of the screen during and after air calibration.
2. The "Zero" is shown at the right bottom of the screen during and after air calibration.
3. Both "Air" and "Zero" is shown after 2 points calibration.

Note:

You can press back to the measurement mode during calibration and all the calibration point is saved. When the measured signal is out-ranged, the sign "Err" will be showed, possibly the aging electrode or the polluted standard solutions lead to this.

7.3.7 P07 Reverting to Factory Default Setting

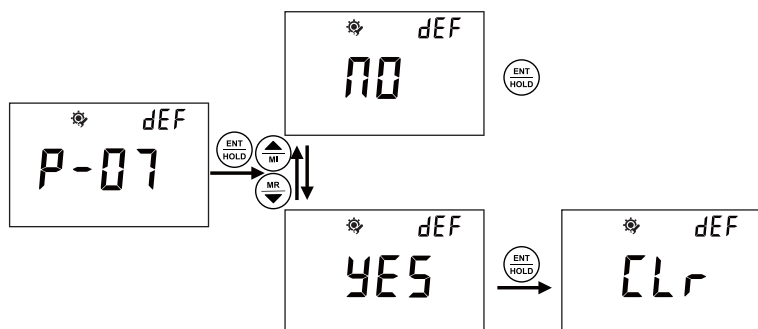

- In P-07, you can select NO or YES to not reverting or reverting to factory settings by pressing .
- Please refer to above description steps to set up P-07.
- If select YES, the meter will revert all the settings to factory defaults and all the settings will lost forever. The unit will restart at the same time.
- You can go to next parameter setting by pressing , or pressing key to quit and go back to measurement mode.

Note:

1. During setting, you can press key to quit setting whenever necessary.
2. During setting, you can adjust anything twinkling by pressing . If it is the data twinkling, you can speedy adjust the data by pressing .

4.2 Display Character Table

SEN	Sensor	CODE	Password Setting
ES	Automatic Temperature Compensation	DEF	Factory Defaults
EC	Manual Temperature Compensation	SL1	Sensor Slope 1
Auto	Automatic Temperature Compensation	SL2	Sensor Slope 2
Manual	Manual Temperature Compensation	SAVE	Save Data
Slope	Electrode Slope	Err	Error
Hd	autolock	ON	On
ADF	Auto Off	OFF	Off
NONE	no stored data	NO	No
CLr	Clear data	YES	Yes
d-	place of the stored data	OUr	Temperature value Over
Offset	Sensor Offset	Udr	Temperature value Under
P-	Menu item	FULL	Full Data Storage
		OUEr	Measuring Value Over
		UNdr	Measuring Value Under
buF	Buffer Solution		
NIST	NIST Standard		
USA	USA Standard	OR	nA output of electrode
		SLP	Sensor slope
tDS	TDS	PrE	Atmospheric pressure
SAL	Salinity	SAL	Salinity
tRF	Temperature Base	OSP	%
COE	Coefficient	OC	mg/L
OFFS	Offset	OPr	DO electrode voltage

pH / ORP PH200 Meter

- New design, Comfortable holding, Easy carrying, Simple Operation
- 65*40mm, large LCD with backlight for easy meter information reading
- IP67 rated, dustproof and waterproof, Floats on water
- Up to 3 points auto-buffer-recognition: Zero offset, Slope of Acid/Alkali segment, Ensure accurate measuring results for the full range
- One key to check through all the settings, including: Zero offset, Slope of Acid/Alkali segment, and all the settings
- Auto lock function
- 50 data sets memory stores and recalls
- Auto Power off saves battery after 10-mins non-use
- 2*1.5V 7AAA battery, long battery life
- CP337 Operating Carrying Pouch

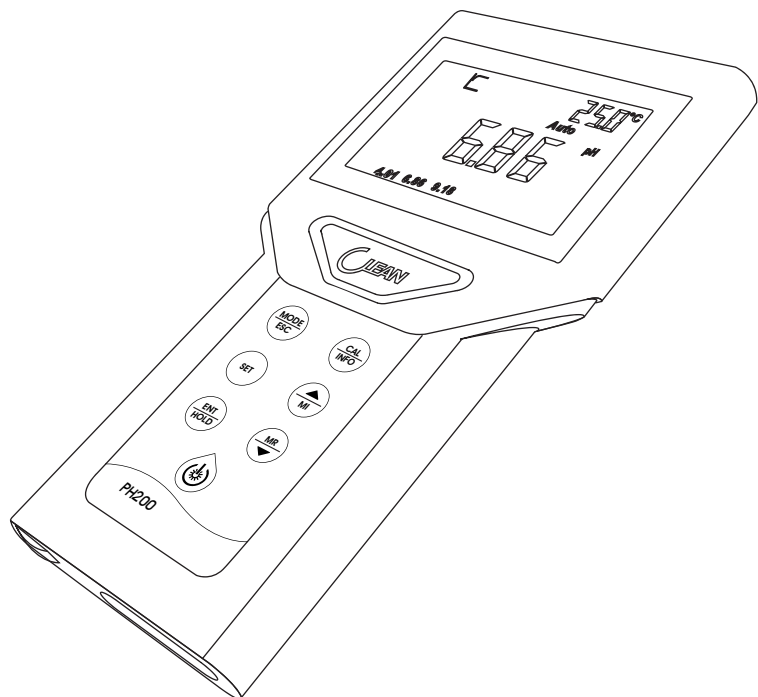

7.3.6 P06 Clearing Memory Function

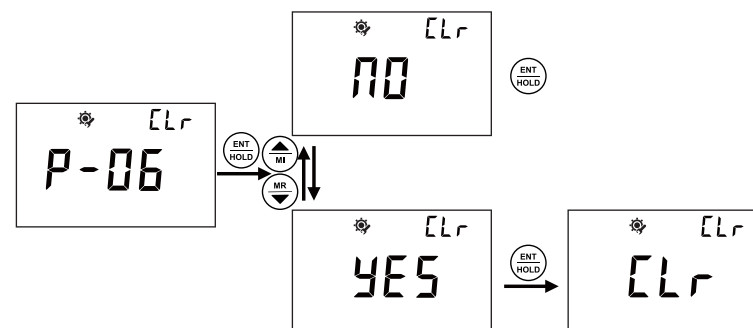

- In P-06, you can set the Clearing Memory Function.
- Please refer to above description steps to setup P-06.
- If select YES, the meter will clear all the saved data.
- You can go to next parameter setting by pressing , or press key to quit and go back to measurement mode.

7.3.4 P04 Auto Lock Function Setting

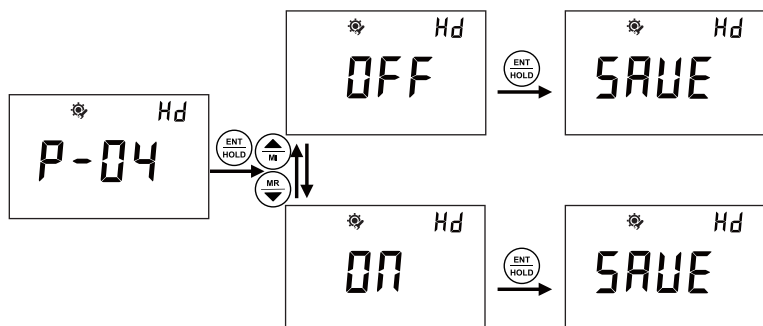

- In P-04, you can set the Auto Lock Function.
- Please refer to above description steps to setup P-04.
- If the Auto Lock Function is ON, the meter can lock the measured value after the reading had stabilized and display . Press to unlock.
- You can go to next parameter setting by pressing , or press key to quit and go back to measurement mode.

7.3.5 P05 Auto Power Off Setting

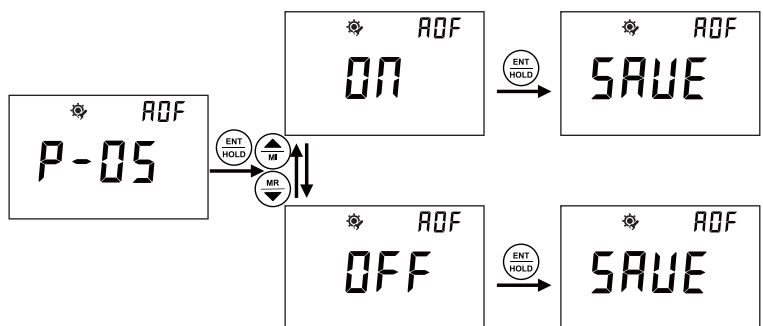

- In P-05, you can set the Auto Power Off Function.
- Please refer to above description steps to setup P-05.
- If the Auto Power Off is ON, the meter will power off if no operation in 10mins.
- You can go to next parameter setting by pressing , or press key to quit and go back to measurement mode.

5.1 Technical Specifications

pH	Range	-2.00 16.00 pH
	Resolution	0.01 pH
	Accuracy	±0.2% F.S.
ORP	Range	-2000~2000 mV
	Resolution	1 mV
	Accuracy	± 0.2% F.S.
Temperature	Range	-10.0 °C~110.0 °C
	Resolution	0.1 °C
	Accuracy	± 0.2 °C
Power	Power supply	2*7 AAA batteries
	Working time	>500 hrs
pH Buffer Kinds	NIST	4.00 6.86 9.18
	USA	4.01 7.00 10.01
Others	Environment	-5 °C~60 °C, Relative humidity 90%
	Memory	50 sets

5.2 Browse the parameter

Long press for 3 seconds in measurement mode.

Then press to browse the parameters

1. Zero offset
2. Slope
3. High/Low segment of the slope
4. Buffer kinds
5. Temperature compensation
6. Hold Auto Lock
7. Auto power off
8. Battery power

5.3 pH Set Up

5.3.1 P01 pH Standard Solution

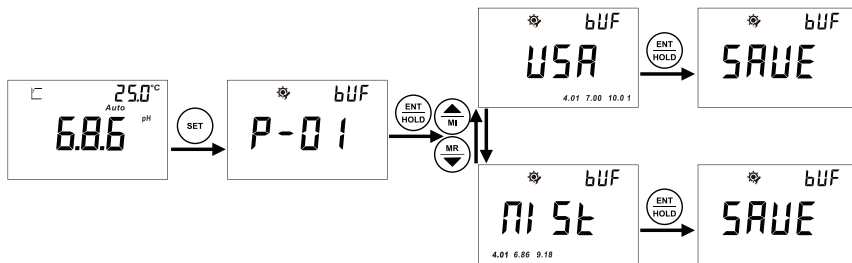

After power-up, the unit will enter the measurement mode. Factory default is pH measuring

- mode. You can switch between the pH measurement mode and the ORP measurement mode by pressing the **MODE/ESC** Key.
- Press **SET** to enter SET up step; Press **CAL/WFO** to enter the Electrode Calibration mode.
- In P-01, you can select a group of buffer solutions as a standard: USA (10.01 \boxtimes 7.00 \boxtimes 4.01) or NIST (4.01 \boxtimes 6.86 \boxtimes 9.18).
- Please refer to above description steps to set up P-01.
- You can go to next parameter setting by pressing **MR/ENT/HOLD**, or pressing **MODE/ESC** key to quit and go back to measurement mode.
- Factory default: NIST

7.3.2 P02 Salinity Compensation



- In P-02, you can set up Salinity concentration value for compensation to get the better measurement result.
- Please refer to above description steps to setup P-02.
- Range: 0.0-40.0mg/L
- You can go to next parameter setting by pressing **MR/ENT/HOLD**, or press **MODE/ESC** key to quit and go back to measurement mode.

7.3.3 P03 Temperature Offset



- In P-03, you can set up temperature offset value for better measurement result.
- Please refer to above description steps to setup P-03.
- Range: +10°C
- You can go to next parameter setting by pressing **MR/ENT/HOLD**, or press **MODE/ESC** key to quit and go back to measurement mode.

7.2 Browse the parameter

Long press  for 3 seconds in measurement mode.





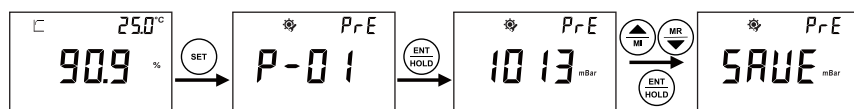

Then press  or  to browse the parameters

1. Working voltage
2. Slope
3. Zero offset
4. Manual Temperature compensation
5. Atmospheric Pressure
6. Salinity
7. Hold Auto Lock
8. Auto power off
9. Battery power

7.3 pH SET UP









7.3.1 P01 Atmospheric Pressure



- In measurement mode, press  to switch between Saturation Percentage and Oxygen concentration mg/L. Press  to enter into parameter setting mode. Press  to enter into electrode calibration mode.
- In P-01, you can adjust Atmospheric Pressure value for compensation to get the better measurement result.
- Please refer to above description steps to setup P-01.
- Range: 600mbar-1400mbar.
- You can go to next parameter setting by pressing  or , or press  key to quit and go back to measurement mode.

5.3.2 P02 Manual Temperature setting



- After entering P-02, you can set the manual temperature by pressing  or . Long press  or  for speedy setting. Confirm your setting by pressing .
- Manual Temperature setting range: 0°C --100°C.
- Please refer to above description steps to set up P-02.
- You can go to next parameter setting by pressing  or , or pressing  key to quit and go back to measurement mode.

Note:

1. Please make sure the Temperature Electrode is UNPLUGGED when manual Temperature compensation. Otherwise, the unit will display "Err" and go back to the set up menu for fresh operation. The "Manual" is displayed beneath the main screen normally.
2. It is not working to unplug the Temperature Electrode while setting. You have to set again after removing the electrode and quit the current mode.

5.3.3 P03 Temperature Offset setting

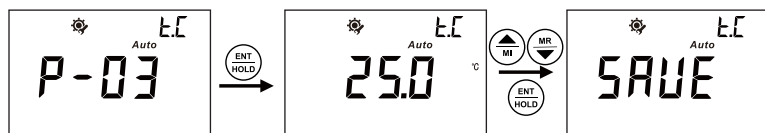

- After entering P-03, you can set the temperature to the appropriate value by pressing according to the actual temperature. Long press for speedy setting. Confirm your setting by pressing .
- Temperature Offset range: +10°C.
- Please refer to above description steps to set up P-03.
- You can go to next parameter setting by pressing , or pressing key to quit and go back to measurement mode.

Note:

1. Please make sure the Temperature Electrode is PLUGGED when Temperature Offset setting. Otherwise, the unit will display "Err" and go back to the set up menu for fresh operation. The "Auto" will be displayed beneath the main screen the screen normally.
2. It is not working to plug the Temperature Electrode while setting. You have to set again after plugging in the electrode and quit the current mode.

7.1 Technical Specifications

Testing items		
Saturation Percentage	Range	0.0% ~ 400.0%
	Resolution	0.1%
	Accuracy	±0.2% F.S.
Oxygen concentration	Range	0.00 mg/L ~ 40.00 mg/L
	Resolution	0.01 mg/L
	Accuracy	±0.2% F.S.
Temperature	Range	when compensating: 0.0 °C ~ 50.0 °C when testing: 0.0 °C ~ 50.0 °C
	Resolution	0.1 °C
	Accuracy	±0.2 °C
Settings		
Atmospheric Pressure	Range	600 mbar ~ 1400 mbar
	Resolution	1 mbar
	Default	1013 mbar
Salinity	Range	0.0 g/L ~ 40.0 g/L
	Resolution	0.1 g/L
	Default	0.0 g/L
Others		
Power	Power supply	2*7AAA batteries
	Working time	>500 hrs
Environment	Humidity	-5 °C ~ 60 °C, Relative humidity < 90%

Dissolved Oxygen

DO200 Meter

- New design, Comfortable holding, Easy carrying, Simple Operation
- 65*40mm, large LCD with backlight for easy meter information reading
- IP67 rated, dustproof and waterproof, Floats on water
- Unit display: mg/L or %
- One key to check through all the settings, including: Zero offset, slope and all the settings
- Galvanic cell mode, without polarization, easy measuring
- Auto lock function
- 50 data sets memory stores and recalls
- Auto Power off saves battery after 10-mins non-use
- 2*1.5V 7AAA battery, long battery life
- CP337 Operating Carrying Pouch

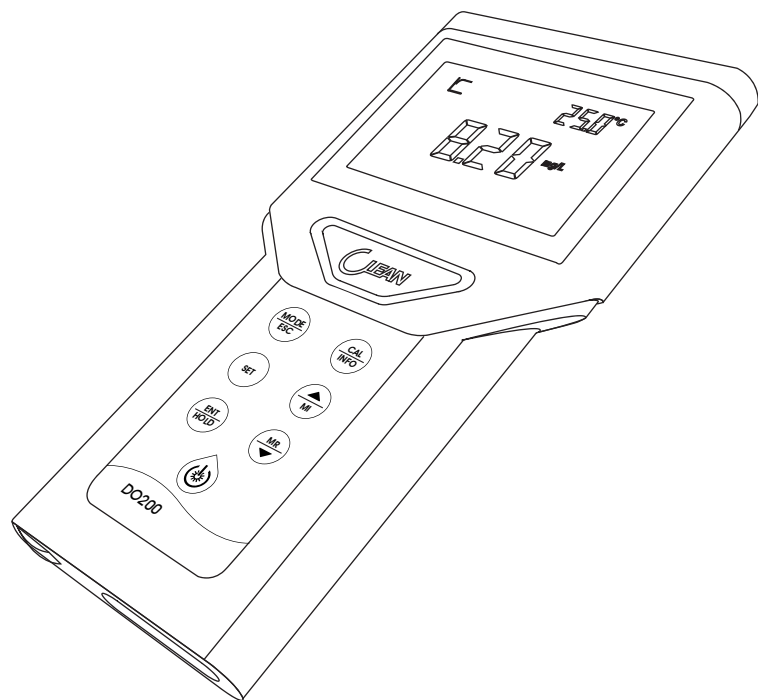

5.3.4 P04 Auto Lock Function setting

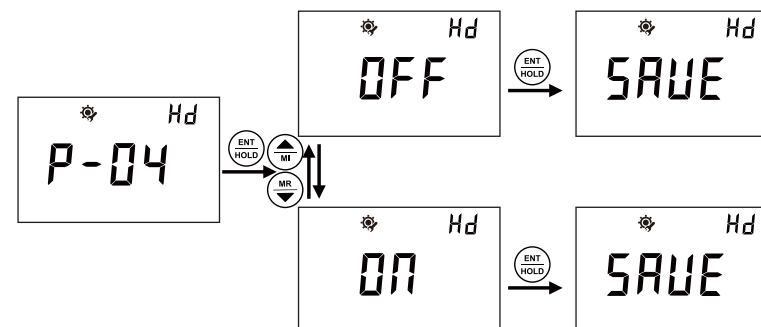

- After entering P-04, you can select ON or OFF the Auto Lock Function by pressing . If the Auto Lock Function is ON, the meter can lock the measured value after the reading had stabilized and display . Press to unlock.
- Please refer to above description steps to set up P-04.
- You can go to next parameter setting by pressing , or pressing key to quit and go back to measurement mode.

5.3.5 P05 Auto Power Off Setting

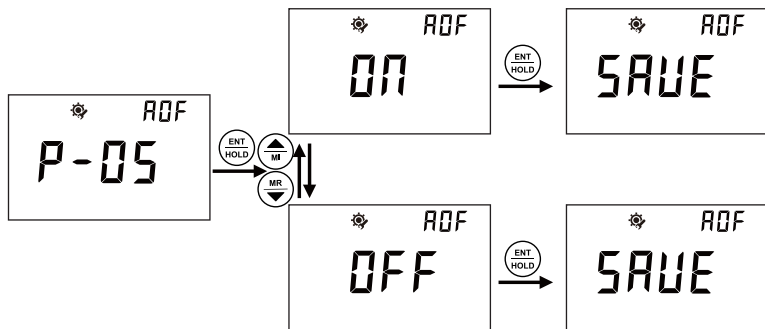

- After entering P-05, you can select ON or OFF the Auto Power Off by pressing . If the Auto Power Off is ON, the meter will power off if no operation in 10mins.
- Please refer to above description steps to set up P-05.
- You can go to next parameter setting by pressing , or pressing key to quit and go back to measurement mode.

5.3.6 P06 Clearing Memory Function

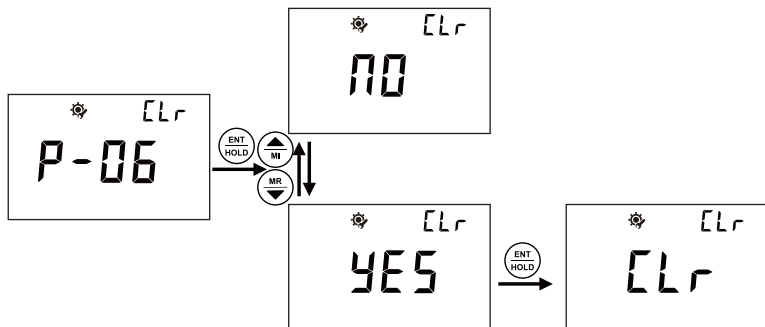

- After entering P-06, you can select NO or YES to not clear or clear the data by pressing . If select YES, the meter will clear all the saved data.
- Please refer to above description steps to set up P-06.
- You can go to next parameter setting by pressing , or pressing key to quit and go back to measurement mode.

6.6.1 Conductivity sensor measuring range:

Cell Constant	Range	Resolution
K=0.01 cm	0.000~4.000 $\mu\text{S}/\text{cm}$	0.001 $\mu\text{S}/\text{cm}$
	0.00~40.00 $\mu\text{S}/\text{cm}$	0.01 $\mu\text{S}/\text{cm}$
	0.0~400.0 $\mu\text{S}/\text{cm}$	0.1 $\mu\text{S}/\text{cm}$
K=0.1 cm	0.00~40.00 $\mu\text{S}/\text{cm}$	0.01 $\mu\text{S}/\text{cm}$
	0.0~400.0 $\mu\text{S}/\text{cm}$	0.1 $\mu\text{S}/\text{cm}$
	0~4000 $\mu\text{S}/\text{cm}$	1 $\mu\text{S}/\text{cm}$
K=1 cm	0.0~400.0 $\mu\text{S}/\text{cm}$	0.1 $\mu\text{S}/\text{cm}$
	0~4000 $\mu\text{S}/\text{cm}$	1 $\mu\text{S}/\text{cm}$
	0~40.00 mS/cm	0.01 mS/cm
K=10 cm	0~4000 $\mu\text{S}/\text{cm}$	1 $\mu\text{S}/\text{cm}$
	0~40.00 mS/cm	0.01 mS/cm
	0~400.0 mS/cm	0.1 mS/cm

6.6.2 Factory Defaults

Instrument Constant	Measurement Range	Initial value
Cell constant type	0.01, 0.1, 1, 10	1.0
Temperature Base	15.0~35.0 $^{\circ}\text{C}$	25.0 $^{\circ}\text{C}$
Conductivity variance ratio per temperature	0.00~10.00%	2.00%
TDS factor	0.40~1.00	0.50
Salinity factor	0.48~0.65	0.65
Temperature bias	+10 $^{\circ}\text{C}$ of the indicated temperature	0.0 $^{\circ}\text{C}$
Auto Lock function	OFF or ON	OFF
Auto Power off function	ON or OFF	ON

6.5 Calibration

Note: Calibration must be done in the following three occasions:

1. before using new sensors or new meter;
2. when the sensor been used for a long time and lead to a widely deviation measuring result.
3. when reference temperature or temperature factor need to be changed.

Calibration step

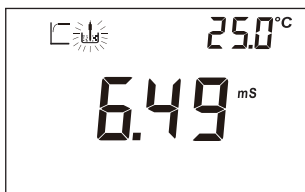

1. In measurement mode, press to enter calibration mode.
2. Dip the electrode into standard solution.
3. After you get a stable current value or the is showed, press to adjust the value figures to match with the standard solution. Adjustable range is +30% of the stable current value. Press to finish the calibration process.
4. The value of cell constant K indicates the status of the electrode.

5.3.7 P07 Reverting to Factory Default Setting

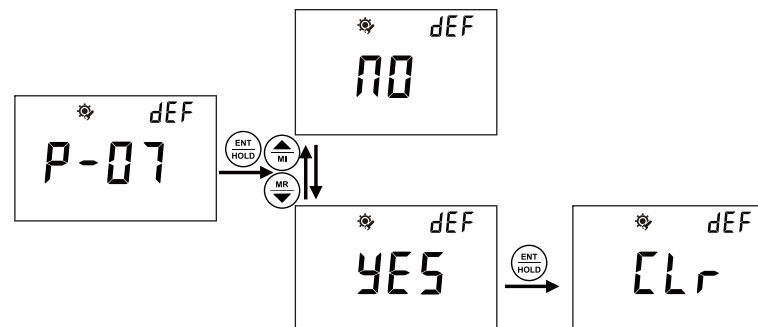

- After entering P-07, you can select NO or YES to not reverting or reverting to factory settings by pressing . If select YES, the meter will revert all the settings to factory defaults and all the settings will lost forever. The unit will restart at the same time.
- Please refer to above description steps to set up P-07.
- You can go to next parameter setting by pressing , or pressing key to quit and go back to measurement mode.

Note:

1. During setting, you can press key to quit setting whenever necessary.
2. During setting, you can adjust anything twinkling by pressing . If it is the data twinkling, you can speedy adjust the data by pressing .

5.4 Calibration Mode

1 pH Calibration

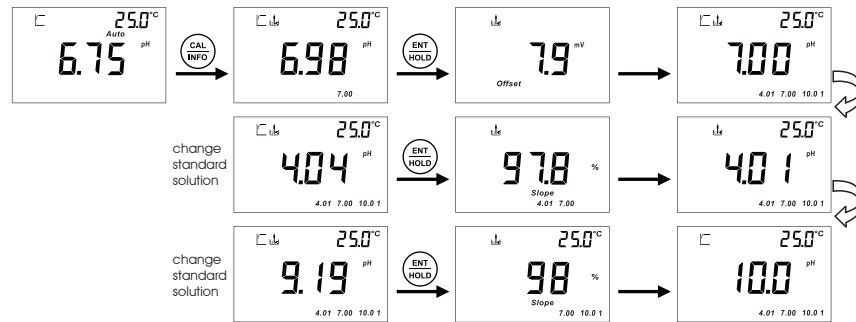

2. Insert the electrode in the pre-set standard solution. You can refer to P-01 explanation on the standard solution setting.

3. Press **CAL INFO** and wait the measuring value to be stabilized. Then press **ENT HOLD** to confirm. The offset slope will be shown after the calibration.

Note: System defaults first point calibration is 6.86pH or 7.00pH.

After the first point calibration, the second point calibration will begin automatically. Then the third point calibration will be continued. The meter will back to measurement mode after all the calibration is done.

Note:

You can press **MODE ESC** back to the measurement mode during calibration and all the calibration point is saved. When the measured signal is out-ranged, the sign "Err" will be showed, possibly the aging electrode or the polluted standard solutions lead to this.

6.4 Setting Parameter

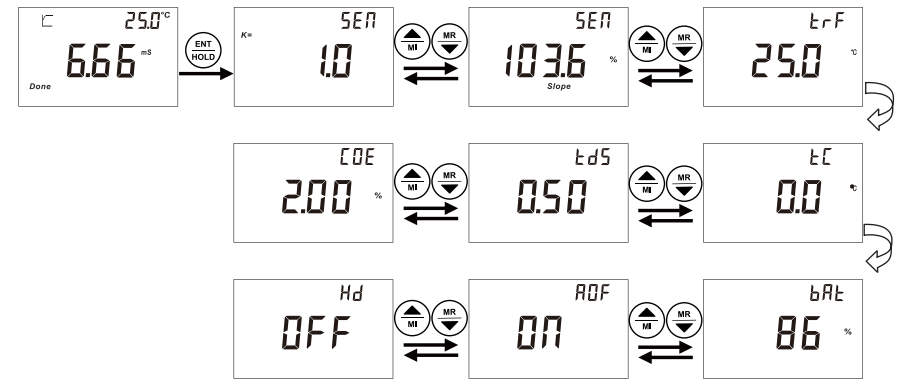

1. Long press **CAL INFO** to enter into Setting parameter when in measurement mode. Press **MI** **MR** to check through all the parameters.

2. Press **MODE ESC** to quit and go back to measurement mode.

6.3.9 P09 Reverting to Factory Default Setting

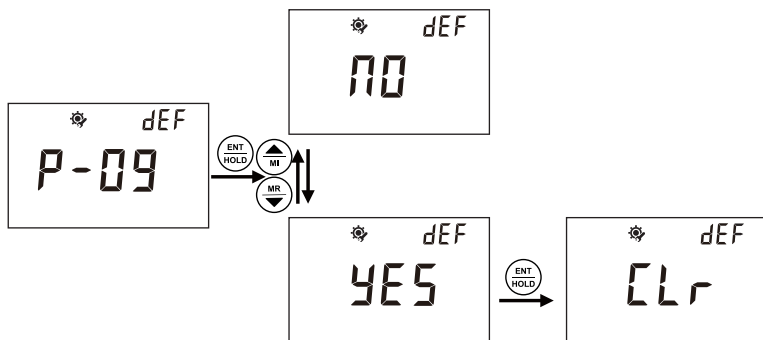

- In P-09, you can select NO or YES to not reverting or reverting to factory settings by pressing .
- Please refer to above description steps to set up P-09.
- If select YES, the meter will revert all the settings to factory defaults and all the settings will lost forever. The unit will restart at the same time.
- You can go to next parameter setting by pressing , or pressing key to quit and go back to measurement mode.

Note:

1. During setting, you can press key to quit setting whenever necessary.
2. During setting, you can adjust anything twinkling by pressing . If it is the data twinkling, you can speedy adjust the data by pressing .

1. You can first set the meter per your request. Otherwise, the setting will be factory defaults.
2. Use tap water or distilled water to clean the pH and the temperature electrode, removing the adhesive impurities on the surface of electrode.
3. After power on, press to select the operation mode (pH or mV).
4. Immerse the pH and the temperature electrode in the solution and stir gently. The measuring mark will twinkle. You can read the value once the data is stabilized and shows the stable mark.

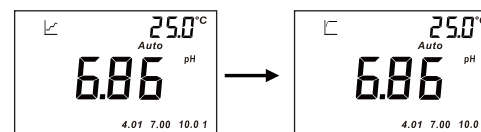



Note:

1. When the screen shows "Auto" means the temperature sensor is working and shows the actual temperature upper right corner. You can refer to the "Temperature Offset setting" if a revision on the temperature is required.
2. If the "Manual" is shown below the screen means the temperature electrode is disconnected and is manual temperature compensation. Factory default is 25.0°C. You can refer to P-02 "Manual temperature setting" to adjust the temperature.
3. The measuring value is stabilized when the screen showed . The is showed if the Auto Lock Function is on. Press to unlock.

5.6 Storage of Data





5.6.1. Storage of measuring data



1. If you need to save the measuring data once it is stabilized, press , the Lot no. will be shown on the upper right of the screen. Press  to save the data. You can also press  to not save. The meter will automatically go back to measurement mode after data saved. The unit at most can save 50 sets data. The screen will show "OVER" if more than 50 sets reminds you the memory card is full.
2. Enter into setting mode P-06 if you need to delete the saved data forever. You can refer to Clearing memory function.



5.6.2. Browse on data storage

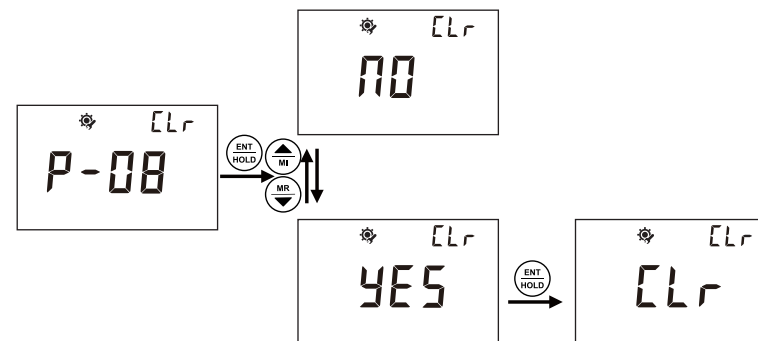

1. Press  to enter into the browse on the data storage, the Lot no. will be shown and data twinkling. Press   to check all the saved data. Press  to go back to measuring mode. If showed "NONE" means no data is saved yet.
2. If you quit and re-entering during checking the data, the meter will freeze in the last set of data.

6.3.8 P08 Clearing Memory Function



- In P-08, you can set the Clearing Memory Function.
- Please refer to above description steps to setup P-08.
- If select YES, the meter will clear all the saved data.
- You can go to next parameter setting by pressing  , or press  key to quit and go back to measurement mode.

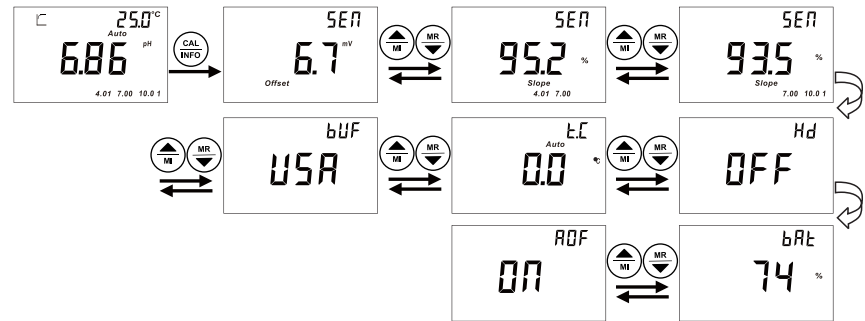

1. Long press to enter into Setting parameter when in measurement mode. Press to check through all the Calibration parameters and Setting parameter.
2. Press to quit and go back to measurement mode.

6.3.6 P06 Auto Lock Function Setting

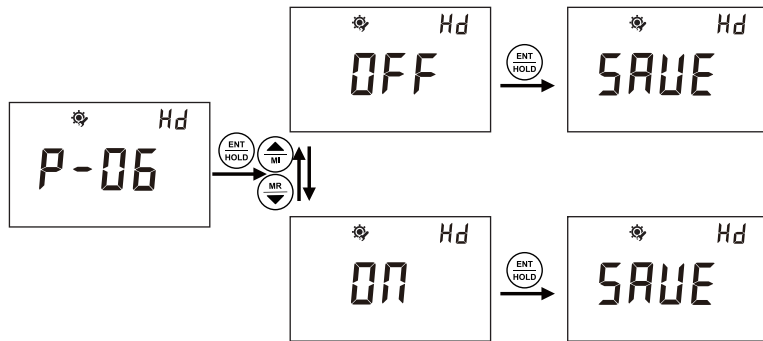

- In P-06, you can set the Auto Lock Function.
- Please refer to above description steps to setup P-06.
- If the Auto Lock Function is ON, the meter can lock the measured value after the reading has stabilized. Press to unlock.
- You can go to next parameter setting by pressing , or press key to quit and go back to measurement mode.

6.3.7 P07 Auto Power Off Setting

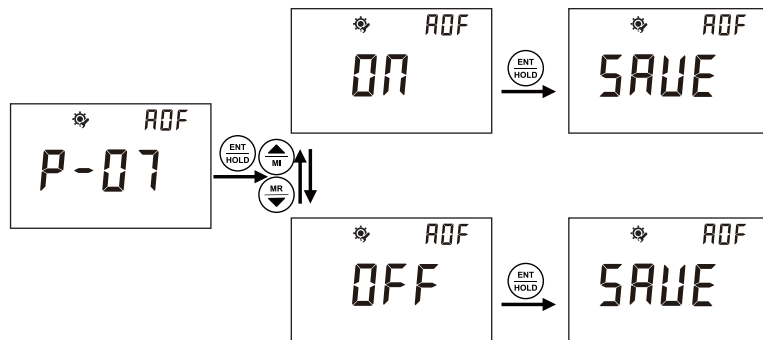

- In P-07, you can set the Auto Power Off Function.
- Please refer to above description steps to setup P-07.
- If the Auto Power Off is ON, the meter will power off if no operation in 10mins.
- You can go to next parameter setting by pressing , or press key to quit and go back to measurement mode.

5.8 Appendix

Factory defaults

Item	Corresponding interface	Factory Defaults
Standard Solution	P-01	USA: 10.01,7.00,4.01
Temperature	P-02	Manual Temperature Compensation 25 °C
Auto Lock	P-04	OFF
Auto power off	P-05	ON
Backlight		OFF

6.3.4 P04 TDS Factor



- In P-04, you can set TDS factor for your application.
- Please refer to above description steps to setup P-04.
- TDS Factor range: 0.40-1.00
- You can go to next parameter setting by pressing , or press key to quit and go back to measurement mode.

6.3.5 P05 Temperature modified Factor



- In P-05, you can set Temperature modified factor for your application.
- Please refer to above description steps to setup P-05.
- Range of Temperature modified Factor: +10°C
- You can go to next parameter setting by pressing , or press key to quit and go back to measurement mode.

6.3.2 P02 Temperature Compensation Base



- In P-02, you can set system base value for conductivity measurement. .
- Please refer to above description steps to setup P-02.
- Range of Temperature Compensation Base: 15.0-35.0°C
- You can go to next parameter setting by pressing , or press key to quit and go back to measurement mode.

6.3.3 P03 Conductivity Temperature Factor



- In P-03, you can set Temperature coefficient for conductivity.
- Please refer to above description steps to setup P-03.
- Range of Conductivity Temperature Factor: 0.00-10.00%
- You can go to next parameter setting by pressing , or press key to quit and go back to measurement mode.

Conductivity / TDS / Salinity

CON200 Meter

- New design, Comfortable holding, Easy carrying , Simple Operation
- 65*40mm, large LCD with backlight for easy meter information reading
- IP67 rated, dustproof and waterproof, Floats on water
- Measuring range: 0.000 us/cm-400.0 ms/cm, Automatic range switching
- Unit display: us/cm;ms/cm,TDS(mg/L), Sal((mg/L),°C
- One key to check through all the settings, including: cell constant, slope and all the settings
- Auto lock function
- 50 data sets memory stores and recalls
- Auto Power off saves battery after 10-mins non-use
- 2*1.5V 7AAA battery, long battery life
- CP337 Operating Carrying Pouch

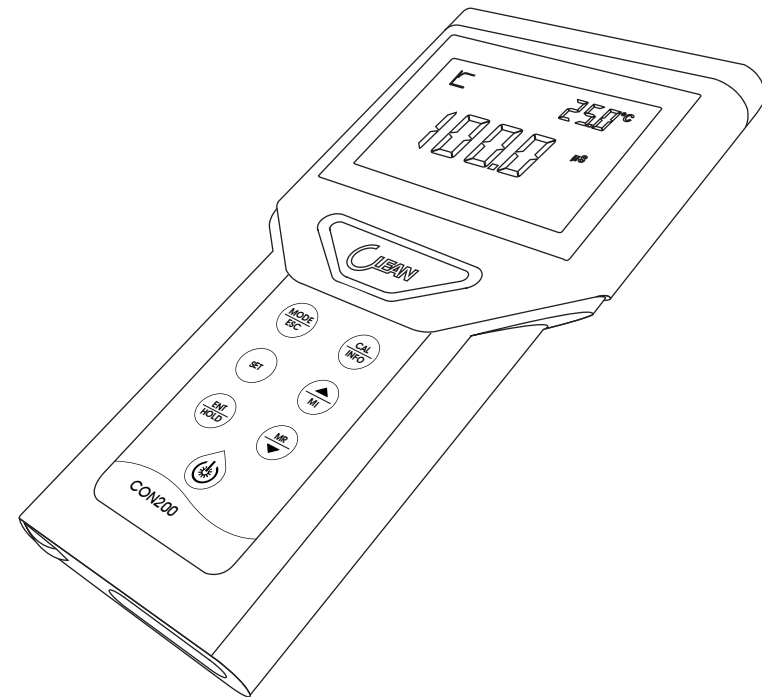

6.1 Technical Specifications

Conductivity	Range	0.000 μ S/cm ~ 400.0 mS/cm
	Resolution	0.001 μ S/cm ~ 0.1 mS/cm
	Accuracy	\pm 0.5% F.S.
TDS	Range	0.000 mg/L ~ 400.0 g/L
	Resolution	0.001 mg/L ~ 0.1 g/L
	Accuracy	\pm 0.5% F.S.
Temperature	Temperature	-10.0 $^{\circ}$ C ~ 110.0 $^{\circ}$ C
	Resolution	0.1 $^{\circ}$ C
	Accuracy	\pm 0.2 $^{\circ}$ C
Power	Power supply	2*7 AAA batteries
	Working time	>500 hrs
Environment	Humidity	-5 $^{\circ}$ C ~ 60 $^{\circ}$ C, Relative humidity < 90%

6.2 Browse the parameter

Long press  for 3 seconds in measurement mode.





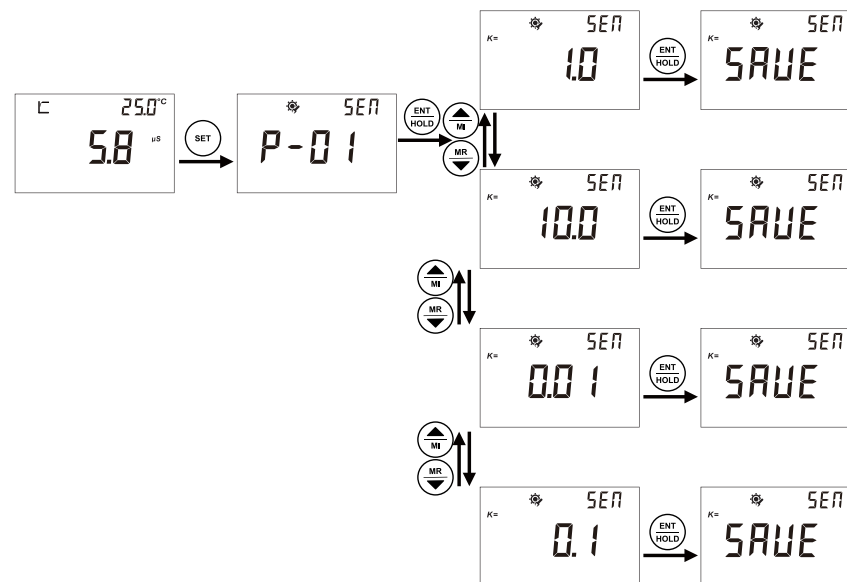

Then press  or  to browse the parameters

1. Cell constant
2. Slope
3. Base temperature
4. Temperature change rate
5. TDS
6. TC Manual Temperature compensation
7. Hold Auto Lock
8. Auto power off
9. Battery power

6.3 SET UP

6.3.1 P01 Cell Constant (K)



- The unit will enter into measurement mode after power on. Factory default is Conductivity measurement mode. Press  to switch between Conductivity measurement mode and Total Dissolved Solids measurement mode. Press  to enter into parameter setting mode. Press  to enter into electrode calibration mode.
- In P-01, you can set up cell constant K of your sensor for measurement application.
- Please refer to above description steps to setup P-01.
- You can go to next parameter setting by pressing  or , or press  key to quit and go back to measurement mode.

Measurement range:

Cell constant K=1.0, For Middle range;

Cell constant K=10, For Wide range (More than 40 mS or 10ppt)

Cell constant K=0.1, For Middle range (Below 40 μ S or 10ppm)

Factory default: Cell constant K=1.0.

8.1 Warranty

CLEAN Instruments warrants this product to be free from significant deviations in material and workmanship for a period of one year from the date of purchase. If repair is necessary and has not been the result of abuse or misuse within the warranty period, please return to CLEAN Instruments and amendment will be made without any charge. CLEAN Instruments Customer Service Center will determine if product problem is due to deviations or customer abuse. Out of warranty products will be repaired on a charge basis.

8.2 Return Of Malfunction Instruments

Authorization must be obtained from CLEAN Instruments Customer Service Center to issue a RIR number before returning items for any reason. When applying for authorization, please include date requiring the reason of return. Instruments must be carefully packed to prevent damage in shipment and insured against possible damage or loss. CLEAN Instruments will not be responsible for any damage resulting from careless or insufficient packing.

Warning: Damage as a result of inadequate packaging is the User / distributor's responsibility. Please follow the guidelines below before transporting.

8.3 Guidelines Or Returning Unit For Repair

Use the original packaging material if possible, when transporting back the unit for repair. Otherwise wrap it with bubble pack and use a corrugated box for better protection. Include a brief description of any faults suspected for the convenience of Customer Service Center, if possible. If there are any questions, feel free to contact our Customer Service Center or distributors.

8.1 Warranty

CLEAN Instruments warrants this product to be free from significant deviations in material and workmanship for a period of one year from the date of purchase. If repair is necessary and has not been the result of abuse or misuse within the warranty period, please return to CLEAN Instruments and amendment will be made without any charge. CLEAN Instruments Customer Service Center will determine if product problem is due to deviations or customer abuse. Out of warranty products will be repaired on a charge basis.

8.2 Return Of Malfunction Instruments

Authorization must be obtained from CLEAN Instruments Customer Service Center to issue a RIR number before returning items for any reason. When applying for authorization, please include date requiring the reason of return. Instruments must be carefully packed to prevent damage in shipment and insured against possible damage or loss. CLEAN Instruments will not be responsible for any damage resulting from careless or insufficient packing.

Warning: Damage as a result of inadequate packaging is the User / distributor's responsibility. Please follow the guidelines below before transporting.

8.3 Guidelines Or Returning Unit For Repair

Use the original packaging material if possible, when transporting back the unit for repair. Otherwise wrap it with bubble pack and use a corrugated box for better protection. Include a brief description of any faults suspected for the convenience of Customer Service Center, if possible. If there are any questions, feel free to contact our Customer Service Center or distributors.